

IR Receiver Module

RPM7100 series

RPM7100 series are remote control receiver modules. Small-sized, light-weight, and low current consumption modules have been achieved by using resin mold.

●Applications

All household electric appliances such as TV, DVD, air conditioner and audio equipment.

●Features

- 1) Low current consumption. (0.95mA Typ.)
- 2) High ripple rejection.
- 3) 3 types of holders available for each set.

●RPM7100 series

Carrier frequency	Straight type RSIP-A3	L forming RSIP-A3 V4	with holders		
			Horizontal board (High) RSIP-A3 (H3)	Vertical board RSIP-A3 (H4)	Horizontal board (Low) RSIP-A3 (H5)
36.0kHz	RPM7136	RPM7136-V4	RPM7136-H3	RPM7136-H4	RPM7136-H5
36.7kHz	RPM7137	RPM7137-V4	RPM7137-H3	RPM7137-H4	RPM7137-H5
37.9kHz	RPM7138	RPM7138-V4	RPM7138-H3	RPM7138-H4	RPM7138-H5
40.0kHz	RPM7140	RPM7140-V4	RPM7140-H3	RPM7140-H4	RPM7140-H5

●Absolute maximum ratings (Ta = 25°C)

Parameter	Symbol	Limits	Unit
Supply Voltage	V _{cc}	-0.3~+7.0	V
Storage temperature	T _{stg}	-30~+100	°C
Operating temperature	T _{opr}	-10~+75	°C
Soldering temperature	T _{sol}	260*	°C

* 3mm from the lead root within 5s.

●Recommended operating conditions (Ta = 25°C)

Parameter	Symbol	Min.	Typ.	Max.	Unit
Supply Voltage	V _{cc}	4.5	5.0	5.5	V

Photo Link Module

●Block diagram

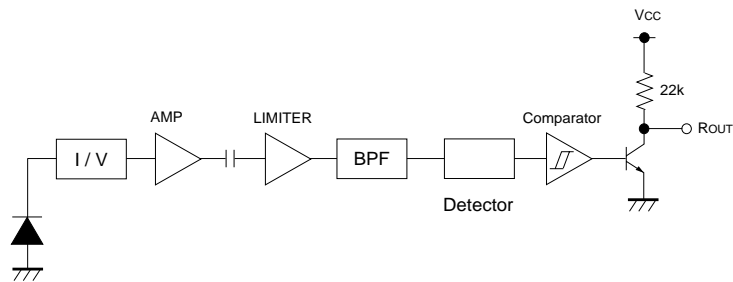

●Terminal description

Pin No.	Pin name	Function
1	ROUT	OUTPUT TERMINAL
2	GND	GROUND
3	Vcc	POWER SUPPLY



●Electrical characteristics (Unless otherwise noted, Ta = 25°C Vcc=5V)

Parameter	Symbol	Min.	Typ.	Max.	Unit	Conditions
Consumption Current	I _{CC}	–	0.95	1.5	mA	No outside light, No signal input
Effective Distance	L	8	15	–	m	Outer light condition E _e < 10 (lx) *1
High Level Output Voltage	V _H	4.5	–	–	V	*1
Low Level Output Voltage	V _L	–	–	0.5	V	I _{sink} =200μA *1
ON Pulse Width	T _{ON}	400	600	800	μs	Outer light condition E _e < 10 (lx) *1
OFF Pulse Width	T _{OFF}	400	600	800	μs	Outer light condition E _e < 10 (lx) *1
Center frequency	f _o	–	*3	–	kHz	
Horizontal half angle	θ 1/2	–	45	–	deg	*2
Vertical half angle	θ 1/2	–	35	–	deg	*2

*1 600/600μs burst wave is transmitted by standard transmitter. However, it must be measured after the initial transmission pulse is 100 pulse.

*2 It is an angle when the linear arrival distance become half.

*3 Four types of frequencies : 36, 36.7, 37.9, 40kHz.

● Measurement Conditions

(1) Transmit signal

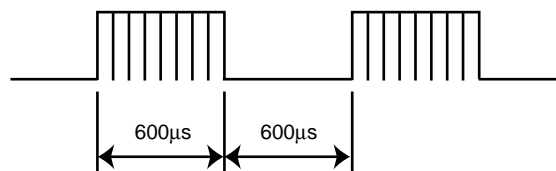

Carrier frequency=f_o, Duty=50%

Fig.1 Transmit signal

Photo Link Module

(2) Standard transmitter

$\lambda_{\text{peak}}=940\text{nm}$
 $\lambda_{\Delta}=40\text{nm}$

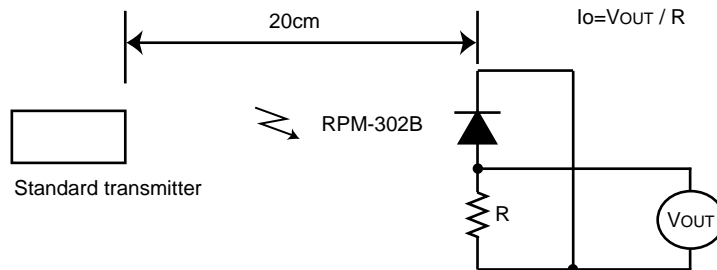

Fig.2 Measurement of standard transmitter proofreading

When standard transmitter output the signal at Fig.1 standard photodiode output become $I_o=5\mu\text{Ap-p}$ under the measurement condition Fig.2.

(The radiant intensity of standard transmitter : 50mW / sr)

RPM-302B : standard photodiode has short current $I_{sc}=27\mu\text{A}$ at $E=1000(\text{lx})$
 (using CIE standard light source A)

(3) Measurement effective distance, horizontal & vertical half angle

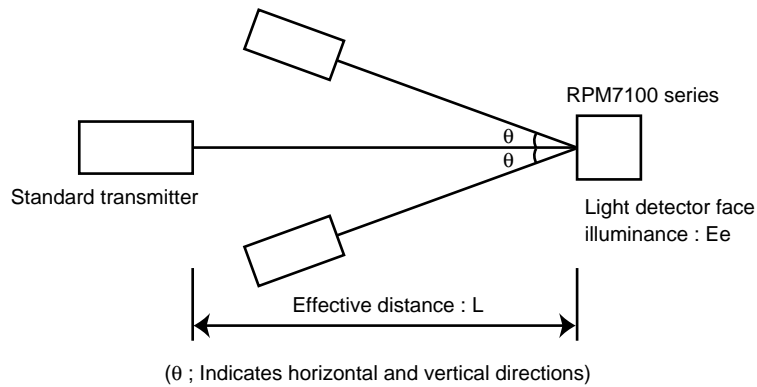

Fig.3 Measurement condition for effective distance

Effective distance L : Effective distance at $\theta=0^\circ$ Fig.3

Horizontal & vertical half angle θ : The angle which effective distance became 50% of L.

Photo Link Module

(4) Output signal

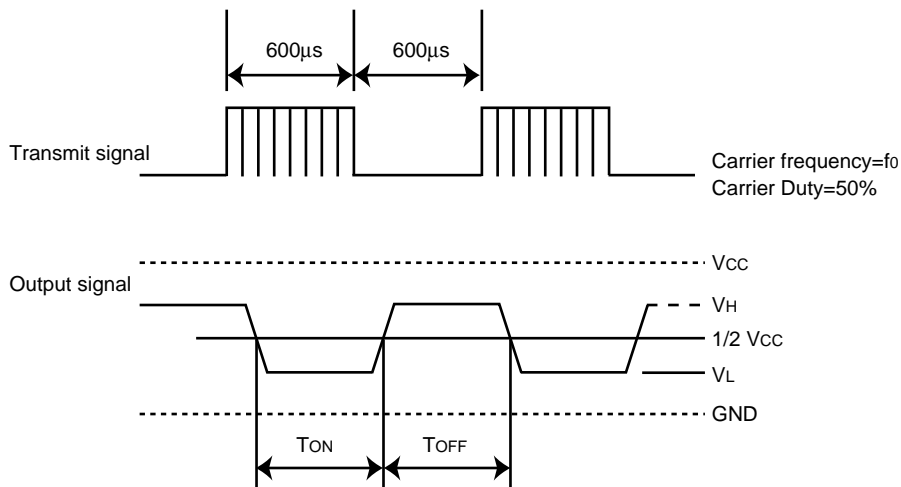

Fig.4

(5) Measurement circuit for the output voltage and the consumption current

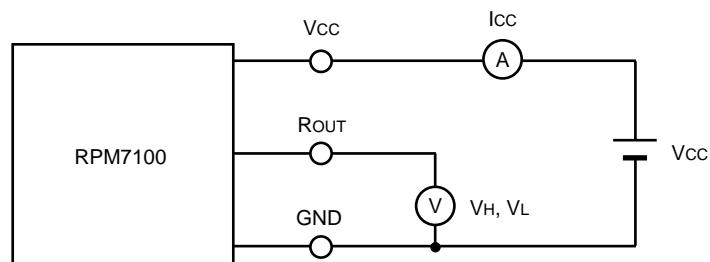

Fig.5

●Notes

- (1) All characteristics of the receiver in this specification are specified by supplying burst wave form with ROHM standard transmitter (Shown as 8 (2)).
If in case of other burst wave form will be used, please check these spec. Carefully under the evaluations.
- (2) When the receiver will be used as the wire-less remote controller, please use the signal method the signal format which refer to "Measures to prevent malfunctioning of IR remote-controlled electric home appliances". (Published July 1987 by Association of Electric Home Appliances)
If using other signal method, signal format, (ex: signal format which not including the leader signal) the receiver might have chances to miss-function.
- (3) Please set up transmitter's carrier frequency as same as the receiver's f_0 frequency. Otherwise error might be occurred.

Photo Link Module

(4) If transmission signal has non-continuous carrier, error might be occurred. Continuous carrier is necessary.

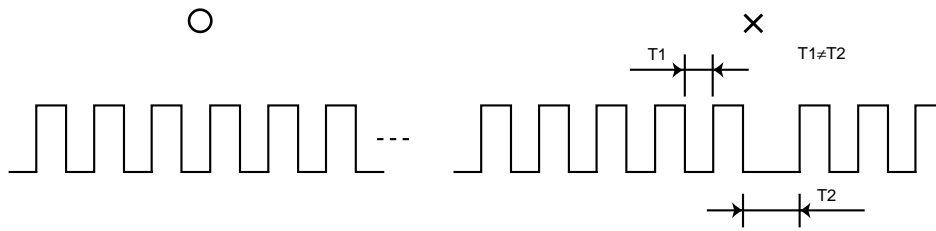

(5) The receiver was designed to use as in-door use only.

Therefore, please understand that the receiver cannot cover all characteristics, in case of using it out-door.

(6) Noise environment (Light noise from inverter Lamp, and other kind of Lamps, Power ripple, electromagnetic noise from power circuit, and etc) may cause a reduced effective distance.

(7) Emitting unit (remote control transmitter) has to be considered about its emitting device function, characteristics and characteristics of the receiver.

(8) Please connect 'Holder' on to the 'Ground (GND)' of PCB. If the holder is not connected to the GND, there is a possibility of worsening the characteristics of product.

(9) Do not supply unnecessary stress to lead.

(10) Please pay careful attention to the lens.

It might have a chance to miss-function when the lens get dust or dirty. And also please do not touch the lens.

(11) In order to prevent IC from ESD, human body and solder iron, etc. are required to be grounded.

●Electrical and optical characteristics curves

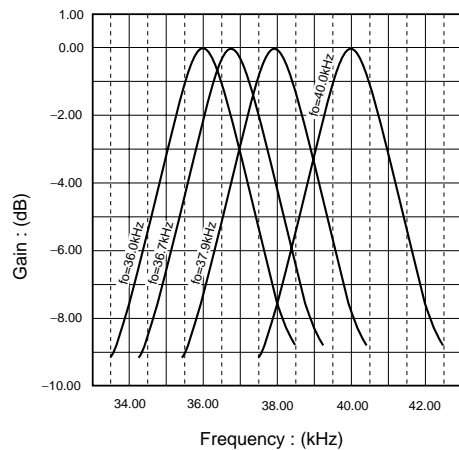

Fig.6 BPF characteristic

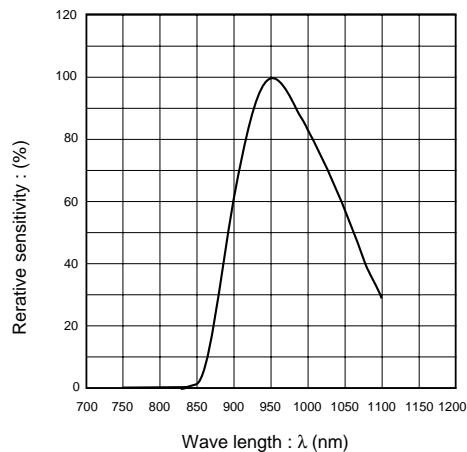

Fig.7 Optical bandwidth of the photo-diode encapsulation

Photo Link Module

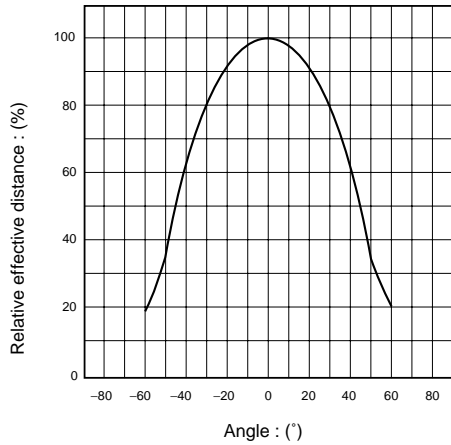

Fig.8 Direction characteristic (Horizontal direction)

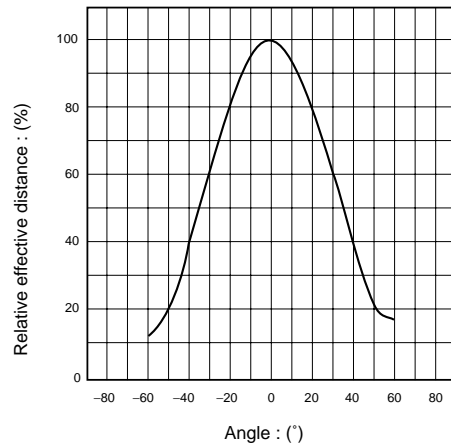
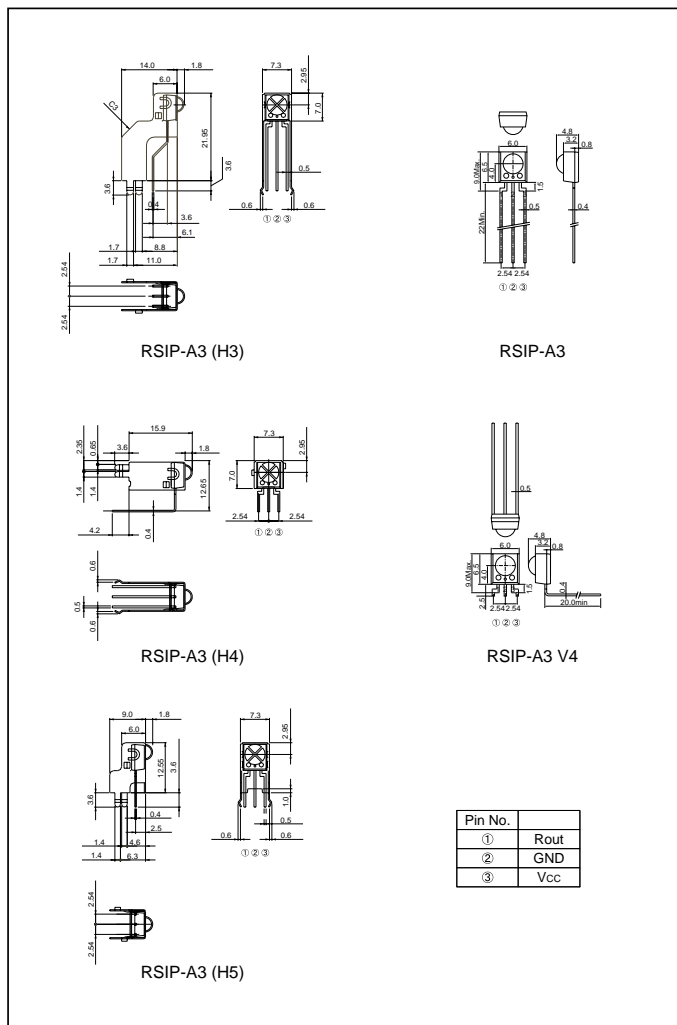

Fig.9 Direction characteristic (Vertical direction)

●External dimensions (Units : mm)



This datasheet has been download from:

www.datasheetcatalog.com

Datasheets for electronics components.